

Product Catalogue



CONTENTS



4

TKS / AIR HANDLING UNIT



8

TNAS / POOL DEHUMIDIFICATION UNIT

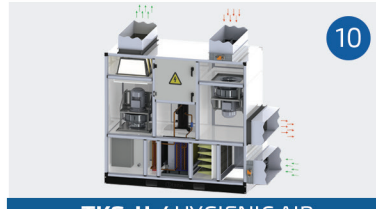

10

TKS-H / HYGIENIC AIR HANDLING UNITS



12

TKS-R / ROOFTOP

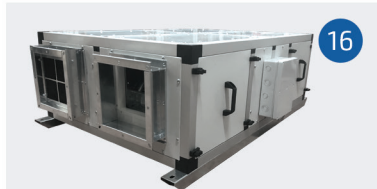

16

TIGK-HP / HEAT PUMP HEAT RECOVERY UNITS



18

TIGK / HEAT RECOVERY UNIT

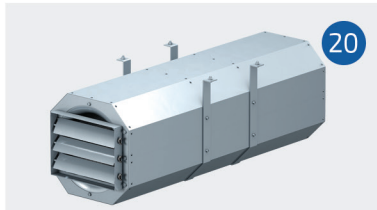

20

TDEF / AXIAL JET FAN



24

TDEF / SMOKE EXHAUST FAN

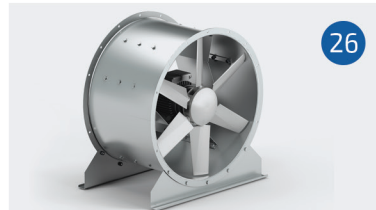

26

TKAF / AXIAL FAN



26

THMF-E / ELECTROSTATIC FILTER KITCHEN FAN UNIT

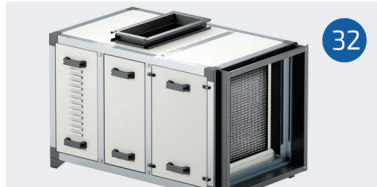

32

THMF / KITCHEN FAN UNIT

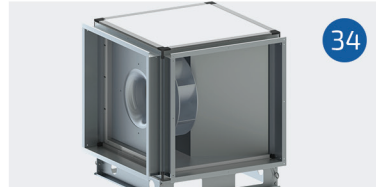

34

TMF / KITCHEN EXHUST FAN

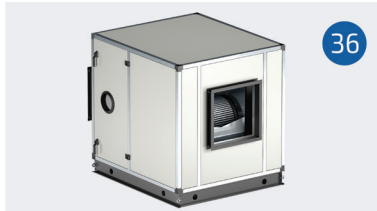

36

THF / VENTILATION UNIT



38

TEH / VENTILATION UNIT

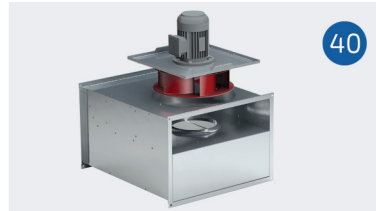

40

TKMF / DUCT TYPE KITCHEN FAN

export@tezelish.com.tr - satis@tezelish.com.tr

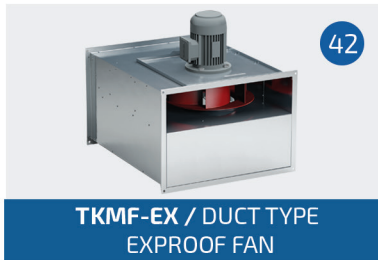

42

TKMF-EX / DUCT TYPE EXPROOF FAN

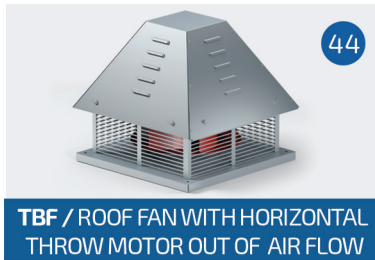

44

TBF / ROOF FAN WITH HORIZONTAL THROW MOTOR OUT OF AIR FLOW



46

TDBF / ROOF FAN WITH VERTICAL THROW



48

TDKF / RECTANGLE AIR DUCT TYPE FAN



50

TCF / ROOF FAN WITH HORIZONTAL THROW



52

TDCF / ROOF FAN WITH VERTICAL THROW



54

TAKF / ACOUSTIC FAN DUCT TYPE



58

TKSF / DUCT TYPE FRESH AIR FAN FOR SHELTER

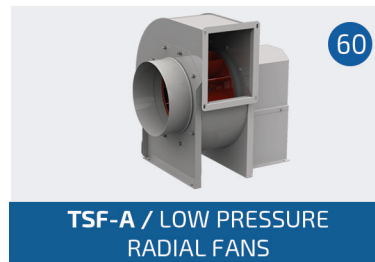

60

TSF-A / LOW PRESSURE RADIAL FANS



62

TYKF / CYLINDRICAL IN-LINE RADIAL FANS



64

TDA / AXIAL FANS



66

CERTIFICATE





ACOUSTIC FAN DUCT TYPE

Model Info

PRODUCT CODE	VOLTAGE (V)	FREQUENCY (HZ)	POWER (kW)	CURRENT (A)	SPEED (Rpm)	SOUND LEVEL dB(A)	AIRFLOW (m ³ /h)	WEIGHT (kg)
TAKF 190	220	50	22	0.10	2300	64.00	560	9.00
TAKF 225	220	50	150	0.7	220	66.00	1050	12.00
TAKF 250	220	50	200	0.9	2440	72.00	1350	13.00
TAKF 280	220	50	250	1.1	2020	70.00	1750	14.00
TAKF 355	220	50	135	0.6	1390	63.00	2500	15.00
TAKF 400	220	50	165	0.75	1350	61.00	4100	21.00
TAKF 450	220	50	400	1.5	1380	65.00	5600	34.00
TAKF 500	220	50	550	2.5	1290	68.00	9000	42.00

TAKF

Our acoustic insulated duct fans are produced in accordance with TSE EN 60335-1 and TSE EN 60335-2-80 standards in the range of 560-10000 m³ / h.

- The case is made of galvanized steel plate.
- 10mm Acoustic insulation on the inside of the inner wall thanks to very low noise level.
- The fans we model in the solidworks program are processed and ready for assembly by automatic CNC machines.
- Aerodynamic frame structure, and the external rotor fan used in high efficiency and low decibel work.
- Designed for use with rectangular ducts
- Thanks to the intervention cover, it can be intervened without dismantling the motor.
- Fan chassis is manufactured with flange.
- 50 micron silicon tapes on the edges of the enclosure is intended to have a leak-proof structure.

Dimensions

MODEL	A	B	L
TAKF 190	300	350	400
TAKF 225	300	350	400
TAKF 250	350	400	500
TAKF 280	400	500	500
TAKF 355	450	500	500
TAKF 400	500	550	550
TAKF 450	550	600	600
TAKF 500	600	650	650

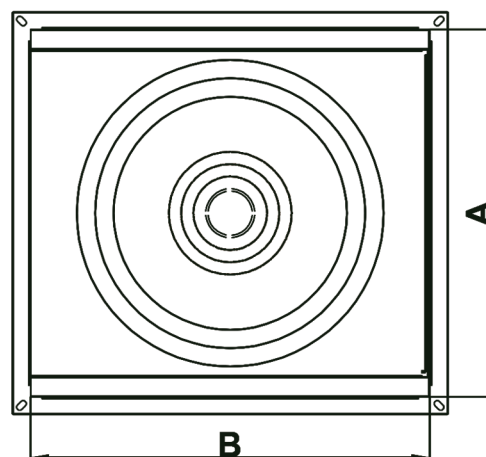
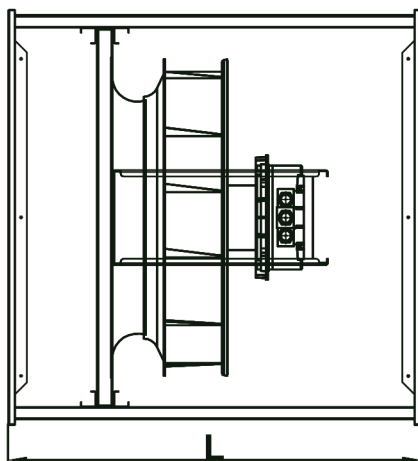

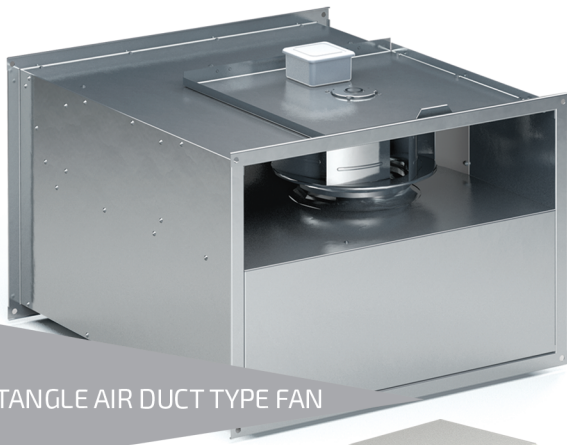

RECTANGLE AIR DUCT TYPE FAN



ACOUSTIC FAN DUCT TYPE

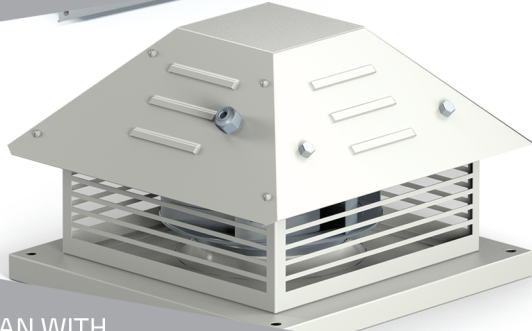

ROOF FAN WITH HORIZONTAL THROW



ROOF FAN WITH VERTICAL THROW

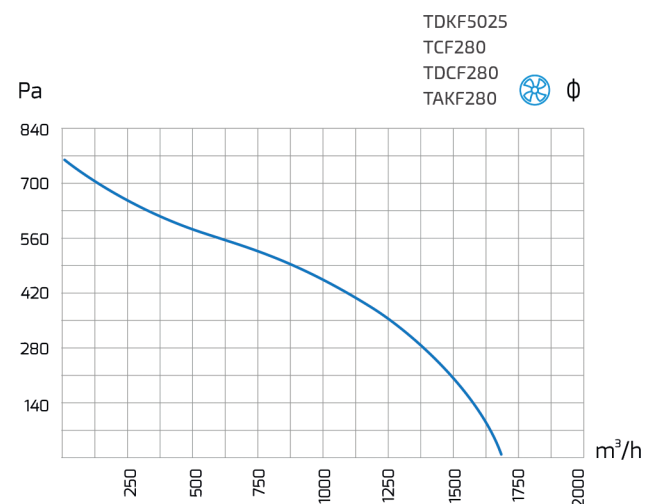
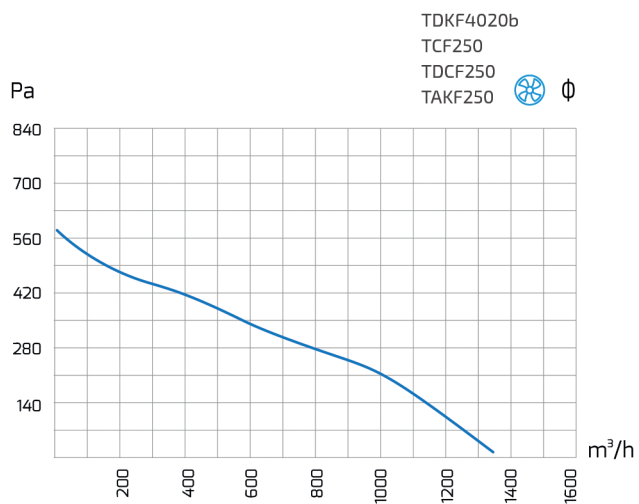
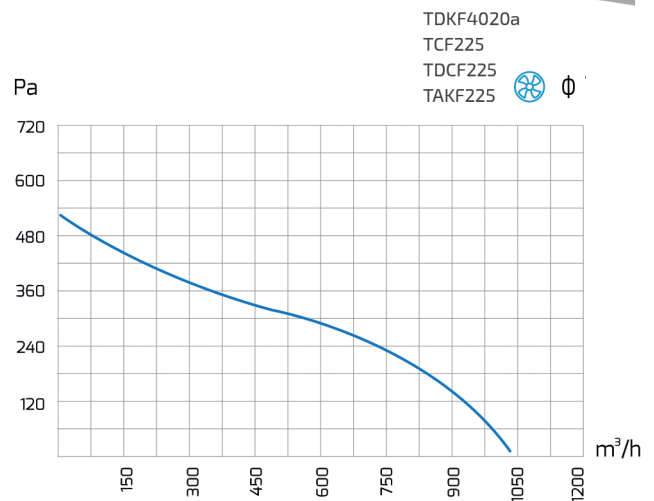
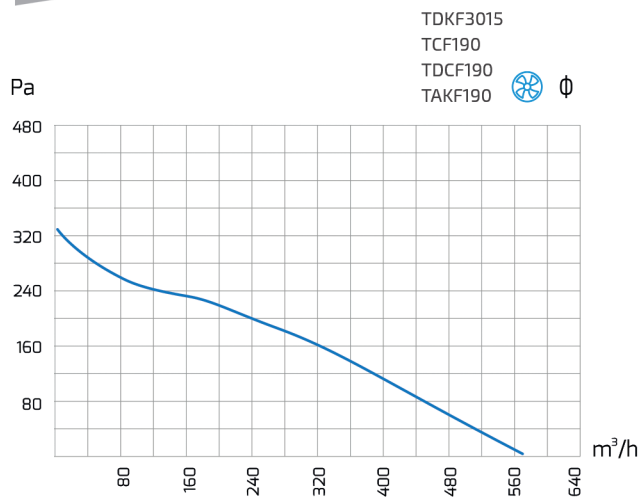

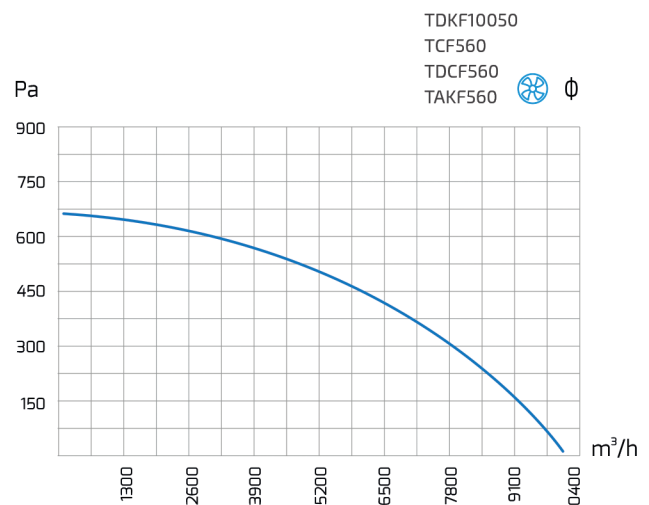
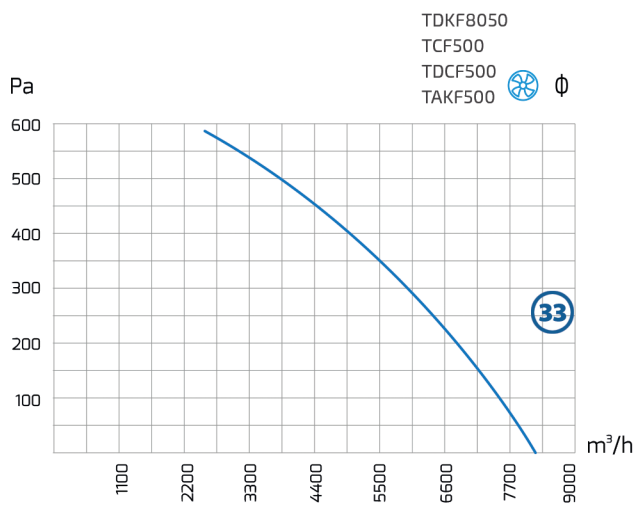
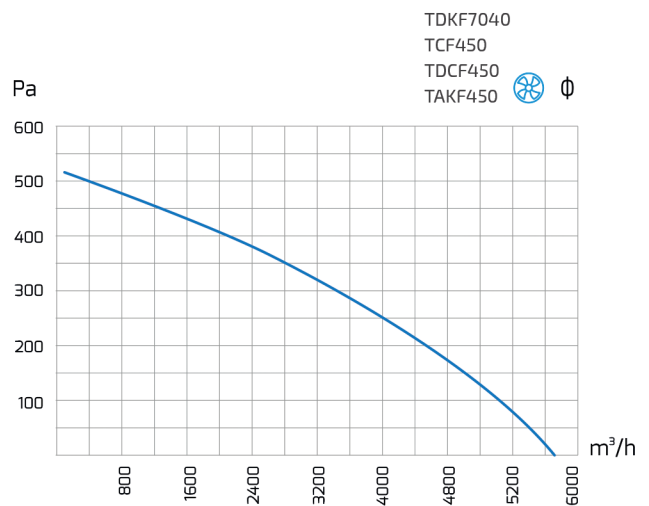
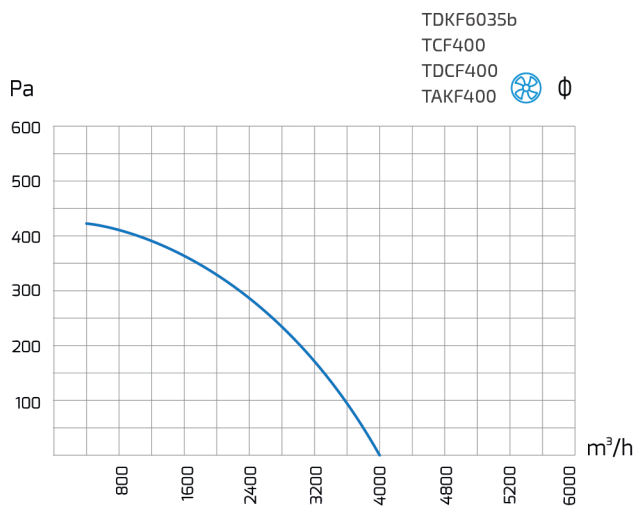
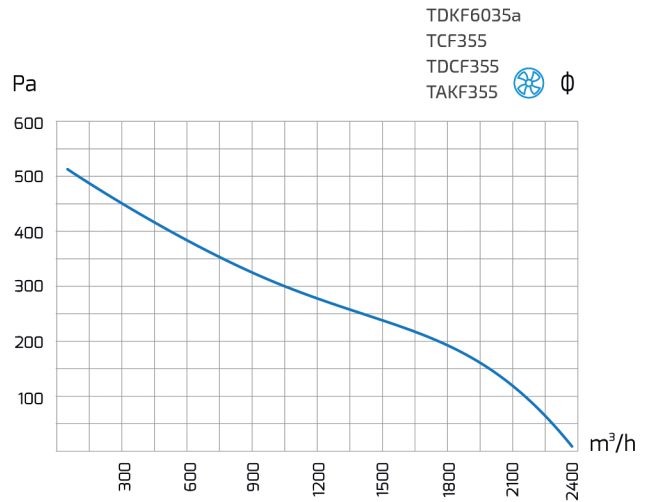
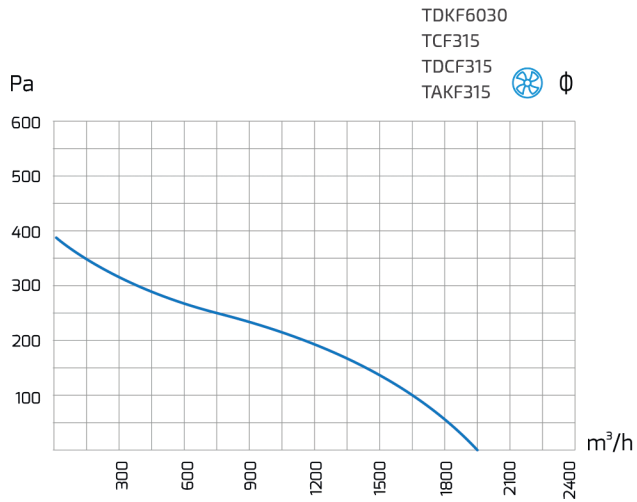



Architecture of high **quality air**



Fatih Mahallesi Yakacık Cd. Sancaktepe - İstanbul - TURKEY

www.tezesh.com.tr



+90 216 311 17 69

satis@tezesh.com.tr



+90 554 534 78 63

export@tezesh.com.tr



+90 506 365 62 54

export@tezesh.com.tr